

KATALOG

FOR GULLSMEDER OG URMAKERE



max johanson og kleiser AS

Innhold

Øremekanismer.....	4
Karabiner og fjærringer.....	5
Øsken og smettringer.....	6
Deleskrin, snepere, og distansetråd.....	7
Henper, sløyfer, brosjemek. og slaglodd.	8
Deler til herresmykker, sikkerhetslenker.	9
Perlelåser sølv og forgylt.....	10
Perlelåser gull, endestykker.....	12
Perletreing.....	13
Søljedeler og kjeder i meter.....	14
Creoler og kjeder.....	15
Ørehullsystem.....	16
Tenger, korntenger.....	18
Luper og annet verktøy.....	21
Måling.....	23
Bor, fres, sag og filer.....	24
Overflatebehandling.....	25
Lodding.....	28
Testing gull og stener.....	29
Urmakerverktøy.....	30
Graving.....	35
Tromling, lodding, lapidering.....	36
Polering.....	37
Rens og tørk.....	38
Trykktesting.....	39
Testing urverk.....	40
Avmagnetisering, motorer.....	41
Galvanisering.....	42
Bord og utstyr.....	43
Oljer, fett, lim.....	44
Polermidler, diverse kjemi.....	45
Heli-produkter.....	46
Rensevæsker.....	48
Verktøysett, pakningssett.....	49
Barettter og stifter.....	50
Overgangstabell batterinumner.....	54

Øremekanismer - selges i par



Stopper standard

G.gull:
585 (842900)
375 (842904)
Hv. gull:
585 (842903)
375 (842905)
Sølv (pk à 20par) (842901)
Forgylt (pk à 20par) (842902)
Roséforgylt (pk à 5 par)
(5250-132-oSR)



Stopper kraftig

Tykkere gods
G. gull:
585 (842906)
375 (842910)
Hvitt gull:
750 (841907)
585 (842909)
375 (842911)
Sølv (pk à 20par) (842907)
Forgylt (pk à 20par) (842908)



Stopper stor

10mm
G. gull:
585 (112720)
Hv. gull:
585 (841940)
(126045)
Sølv (pk à 5 par)
Double (pk à 5 par)
(126044)



Stopper stor m/plate

10mm
Hv. gull 585
(841926)



Stopper edelstål

5mm
(840449)



152/3

Ørestikk m/3mm kule og
åpent øsken og stopper.
Gull 585 (840373)
Hv. gull 585 (840375)
Hv. gull 375
(5-15330-38918-000)
Sølv (840370)
Forgylt (840371)



Nr 119

Ørestikk m/plate og
stopper.
Ø4, 6 el. 8mm
plate.
Kun i sølv.



Allergi nr 2

m/ plastplate 10mm
Pk. á10par.



890006

Plaststopper for ørebøyle i plast
Pk á 5par.



842922

Plaststopper i silikon.
Pk á 5par.



112

Brisur
Gull, sølv
el. forgylt.



300

Ørebøyle med
lås. Sølv el.
forgylt.



302

Ørebøyle
Sølv, el.
forgylt.



303

Ørebøyle
Gull, sølv el.
forgylt.



304

Ørebøyle
Sølv el.
forgylt.



118

m/ perleskål
Ørestikk m/Ø4, 5 el. 6 (8)
mm perleskål m/stopper.
Gull, hvitt gull, sølv el.
forgylt.



90/91

Store øreklips med stol
for påloddning.
Gull el. sølv.



137

Små øreklips med
stol for påloddning.
Kun i gult gull.



139

Øreklips med
8 mm perleskål.
Kun i sølv.



866

Øreklips med lukket øsken.
Sølv el. doublé.



Øreklips, Omega

Gull: 5250-153000GG
Sølv: 5250-153000



124-4

Øreskru med
4mm perleskål.
Gull, sølv el.
forgylt.



125/3

Øreskru med 3mm
kule og åpent øsken.
Gull, hvitt gull, sølv,
el. forgylt.



118

Ørestikk for påloddning.
(Selges i par.)
0,9x10mm.
Gull: 5250-124204
Hvitt gull: 5250-124206
Sølv: 5250-124209

Karabiner og fjærringer



Barokk karabin

Str.	925 S	925 Fg	Dublè	858 Gg	585 Hvg	750 Gg	750Hvg	375 Gg	375 Hvg	Edelstål
9mm	841370	841551	841367	841785	841690	841790	841760	841518	841519	
11mm	841371	841552	841638	841786	841700	841791		841521	841522	
13mm	841372	841553	841369	841787	841710			841523	13-375	841732
16mm	841528	841554	865513	841788						841733
18mm	841527		841545							
20mm				841542						
23mm	841544									

Barokk karabin 90°

Str.	925S	Dublè	585 Gg
9mm	841495	841498	841505
11mm	841496	841499	841506
13mm	841497	841501	841507
15mm	841512	841513	841516



Ur-karabin

Str.	925 S	Dublè
20mm		840871
23mm	840718	



Flat karabin

Str.	925 S	Dublè	585 Gg	585 Hvg
8mm			841556	850369
10mm	850351	850356	850366	850368
12mm	850352	850357	850367	
14mm	850363		850365	
16mm	850354	-21365-	850303	
18mm	850355			



Ur-fjærring

Str.	925 S	Dublè
20mm	820660	820660



Ringlås 12mm

Str.	925 S
12mm	842891



Fjærringer

Str.	925 S	925 Fg	Dublè	585 Gg	585 Hvg	750 Gg	750 Hvg	375 Gg	375 Hvg
5,5mm	820581	820582	-6000-	820950					
6mm	820591	820592	820721	820960	820977	820992	821002	820942	820947
7mm	820601	920602	820731	820970	820987	820993		820943	820987
8mm	820611	820612	820741	820971				-3P980-	
9mm			820751						
10mm	820630		820760						
12mm	820640		820770						

Øsken



Runde

Str./Trådykkelse	925 Sølv	925 Fg	Duble	585 Gg	585 Hvg	585 Hvg. Rh
3mm (0,5)	820309	820336		820303	820328	
3mm (0,6)	820081		820341	860011		860085
3,5mm (0,5)	820318	820337				
4mm (0,5)	820372	820338				
4mm (0,8)	820101		820361	860013		860087
5mm (0,9)	820121		820381	860015		860089
5mm (1,1)	820121A					
6mm (1,0)	820141		820401	860017		
6mm (1,2)	820141A		820411			860058
7mm (1,1)				860018		
7mm (1,2)	820151					
8mm (1,2)	820161		840421	820423		
8mm (1,4)	820161A					
9mm (1,2)			840431	500-90		
9mm (1,4)	820171					
10mm (1,4)	820181		820441			820446
16mm (2,0)	819007					

Ovale

Str./Trådykkelse	925 Sølv	Duble	585 Gg	585 Hvg
3mm (0,5)		820481		
3mm (0,6)	820211		860002	
4mm (0,5)				860087
4mm (0,8)	820231	820491	860004	
5mm (0,9)	820251	820511	860006	860089
6mm (1,0)	820271	820531	860008	860058
7mm (1,1)	820281	820541	859999	
8mm (1,2)	820291	820551	820553	
9mm (1,4)	820301	820561	-510-90gg	

Assorterte øsken

Gross (144stk)



Runde assortert

Str.	925S	Dublè	Rosè
2-6mm	820000	820020	820040

Smettringer

Str.	925S	Dublè
5mm	841382	841392
6mm	841384	841394
7mm	841386	841396



Ovale assortert

Str.	925 S	Dublè
2-6mm	820010	820030

Deleskrin

207529

Deleskrin med to etasjer.



Fylt deleskrin

Enkelt å bruke, enkelt å etterfylle. Fylt med de delene det går mest av i butikk, ett brett med varer i sølv, ett brett med forgylt sølv og doublé.

Inneholder stoppere (standard, kraftige, store, allergi og små for ørebøyer), stikk med kule og øsken, fjærringer og karabiner (barokke og flate). Fylt skrin kan ikke bestilles i nettbutikken, bruk telefon eller e-post.

Sneppere

Gult gull sidesnepper



11mm 00743
14mm 00716

Sølv rhodinert sidesnepper



14x6 mm 842450
14x7 mm 842532
13x8 mm 842512
17x13 mm 842560

Forgylt sølv sidesnepper



5x11 mm 842401

Assorterte sneppere 10stk

Rhodinert sølv 841440

Forgylt sølv 841441



Sølv snepper



3x9mm 842820

Forgylt sølvsnepper



3x9 mm 842821
3x11 mm 842811

Distansetråd

Innvendige mål

Gult gull

7,5-8,5mm 860130
12,5mm 860131

Hvidt gull

12,5mm 860151
14mm 860152

Sølv

7,5-8,5mm 860100
12,5mm 860101
24mm 00624

Rhodinert sølv

19,5 mm 860104



Øyeskruer og hemper

Målene er utvendig på langs.



120 Øyeskrue
m/perleskål og øsken.
Kun sølv.
5, 6 el. 8mm
(innv. ca 1,7mm).



11307 Øyeskrue
m/perleskål med øsken.
Gult gull
3mm



Hempe, glatt
Nr 136B: ca 11,3mm
Gull, sølv el. forgylt.

Nr 136C: ca 8mm
Gull, sølv el. forgylt.

Nr 136D: ca 6,8mm
Gull, hvitt gull, sølv el. forgylt.



Hempe, rillet
Nr 8: ca 10,3mm. Gull, hvitt gull, sølv el. forgylt.

Nr 4: ca 7,7mm.
Gull, sølv el. forgylt.

Nr 2: ca 5,8mm.
Gull, sølv el. forgylt.

Anhengsløyfer



Sølv
23 mm

842199



Sølv
20x16mm

842197



Forgylt sølv
19x14 mm

842204



Sølv
10,5mm

452



Forgylt sølv
8,5mm

459



Rhodinert sølv
10mm

842164



Hvidt gull
14 mm

00499



Hvidt gull
3,8mm m/perleskål.
Ca 10 mm

362

Brosjemekanisme



Kulekrøll stor
nr 170/23
Ca 5,5mm høy,
gult gull el. sølv.



Kulekrøll m/ plate
Stor: ca 6mm høy,
liten: ca 5mm høy.
Kun sølv.



Sjaner 100B
061003
Ca 3,5mm høy.
Passer til bro-
sjestift med stift.
Kun i sølv.



U-sjaner
Ca 3,5mm høy,
Hv. gull
5270-171-002WG
Sølv
5270-95171002



Nysølv med stift
25-55mm



Nysølv med øye
25-55mm



Nysølv med sjaner
20-80mm



Nysølv med bukk
20-80mm

Sølvslaglodd stikke/tråd:

nr 1 vek:

for hårdloddning av 830-sølv, nysølv, kobber, messing og bronse. Smeltetemperatur: 640-710°.

nr 2 middels:

for hårdloddning av 830-sølv, nysølv, kobber, messing og bronse. Smeltetemperatur: 675-720°.

nr 3 hård:

for hårdloddning av 830-sølv, nysølv, kobber, messing og bronse. Smeltetemperatur: 705-740°.

nr 4 vek:

emaljeslaglodd, for hårdloddning av 925-sølv og kobberlegeringer. Smeltetemperatur: 675-745°.

Rep:

for hårdloddning av kobber, messing, bronse, stål, rustfritt stål. Smeltetemperatur: 620-690°.

Slaglodd

Gullslaglodd, plate 2g:

Gult gull:
reparasjonsslaglodd
Vek: lys eller gylden farge
Medium: lys eller gylden farge
Hård: lys eller gylden farge

Hvitt gull: Vek, medium eller hård



Mekanismer til herresmykker og pins



Slipsnålstopper
Nikkel el.
doublé.



Merkestift
Ca 1,2 x 9,7
mm. Sølv el.
nikkel.



Tie tack lås nr 200
Doublé.



Tie tack lås nr 56
Uten pin
Nikkel el. doublé.



Slipskjede
Figaro
Sølv el. forgylt sølv.



Slipskjede
Anker
Sølv el. forgylt
sølv.



Tie tack lås nr 14
Nikkel el. doublé.



Tie tack lås nr 16
Nikkel el. doublé.



**Brystknapp-
mekanisme**
Par i én del, sages i
to. Gult gull.

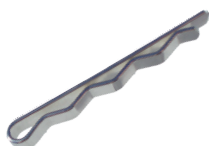

Slipsklype nr 160
Sølv el. forgylt sølv.



Slipssikring nr 155
Sølv el. forgylt sølv.



Slipsbøyle
Sølv el. forgylt sølv.



**Mansjettknapp-
mekanisme**
For påloding, sølv.



**Mansjettknappmek.
m/plate**
Sølv.

Sikkerhetslenker og kjedeforlengere



Sikkerhetslenke (panser) m/fjærring (lås)

Gult gull: P35/7,5(468D.59904)/ trådtykkelse Ø0,35mm/ lengde ca. 7cm
Hvitt gull: P40/7 (822094)/ trådtykkelse Ø0,4mm/ lengde ca. 7cm
Sølv: P45/6 (821170)/ trådtykkelse Ø0,45mm/ lengde ca. 6cm
Sølv/rosé: P45/6 (821171)/ trådtykkelse Ø0,45mm/ lengde ca. 6cm
Doublé: P45/6 (821230)/ trådtykkelse Ø0,45mm/ lengde ca. 6cm

Sikkerhetslenke (panser)

Gult gull: P45/7(822108)/ trådtykkelse Ø0,45mm/ lengde ca. 7cm
Hvitt gull: P35/6 (822083) trådtykkelse Ø0,35mm/ lengde ca. 6cm
Sølv: P45/6 (821140) trådtykkelse Ø0,45mm/ lengde ca. 6cm
Doublé: P35/6 (821180) trådtykkelse Ø0,35mm/ lengde ca. 6cm
Doublé: P40/7 (821190) trådtykkelse Ø0,40mm/ lengde ca. 7cm



Kjedeforlenger:

Sølv: Ø6mm L:7,5cm (822040A)
Sølv: Ø5mm L:7,0cm (822041)
Sølv: Ø10X8mm L:6,0cm (822042)
Sølv/forgylt: Ø6mm L:7,5cm (822046A)
Sølv/forgylt rosé: Ø6mm L:7,5cm (822046B)



Sølv Ø3 mm m/øsken og fjærring L:5cm (822064)

Sølv/forgylt Ø3mm m/øsken og fjærring L:5cm (822065)



Magnetlåser m/ fjærring: Låserstatter, for de som har problemer med låser, f.eks har revmatisme el. dårlig syn. Settes enkelt på kjeder og lenker uten omarbeiding. Kraftig magnetlås.
Sølv: M65-FS (842875)
Sølv/forgylt: M65-FV (842876)
G. gull: M65-FGG (5210-M65FGG)

Perlelåser i sølv og forgylt sølv

Målene er uten ønsken.



Blank rhodinert sølv

7mm 842020
8mm 864842
10mm 842076
12mm 842077
14mm 842078(utgår)
20mm 16139 (utgår)



Satinert rhodinert sølv

8mm 842079
10mm 842080
12mm 842081
14mm 842082



Blank forgylt sølv

7mm 842019
10mm 842083



Satinert og forgylt sølv

8mm 842086
10mm 842087
12mm 842088



Magnet blank sølv

8mm 842877
10mm 842881
12mm 842885
14mm 842148



Magnet matt sølv

8mm 842878
10mm 842882



Magnet blank fg sølv

8mm 842879
10mm 842883
12mm 842887
14mm 842159



Magnet matt fg. sølv

8mm 842880
10mm 842884



KulelåsForgylt sølv

9mm 842011



Matt rhod. sølv 2-rader

20x15mm 18727 (utgår)

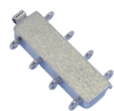

**Matt på toppen
4-rader**

Rhodinert sølv

21,3x6,5mm
13804(Utgår)



**Satinert sølv
Rhodinert el. forgylt**

14,5 mm
18711(utgår)



Easy click, blank rho.sølv
Fjærbelastet

14,5x12,5mm
19286 (Utgår)



Slide-magnetlås
Rhodinert sølv

10 mm 22797(Utgår)



Blank rhod. sølv 3-rader

H3xW16xD12,5mm
842118 (utgår)

Perlelåser i sølv og forgylt sølv

Målene er uten øsken.



**Rho. sølv.
m kulturperle**

8x14mm
840949



**Rho. sølv
m/kulturperle**

8x14mm
840933



**Rho. sølv
m/ kulturperle**

9x16mm
840958



**Rho. sølv
m/ kulturperle**

13,5mm
840945



**Rho. sølv
m/ kulturperle, cz.**

13mm
840966



**Rho. sølv 2rader
m/ kulturperle**

11x14mm
840942



**Rho. sølv 2 rader
m/ kulturperle**

11x14mm
840946



**Rho. sølv 2 rader
m/ kulturperle**

11x14mm
840935



**Rho. sølv 3 rader
m/ kulturperle**

14x16mm
840965



Rhodinert sølv
842048

Forgylt sølv
842049

5x12mm



Rhodinert sølv
842000

Forgylt sølv
842001

5x12mm



Rhodinert sølv.
842002

Forgylt sølv
842003

7x12mm



**Blank Rho. el fg
sølv**

14x5 mm 19381
(utgåar)

Perlelåser i gull og hvitt gull, 585



**Blank gult gull
585**

7mm 864932
8mm 864933
10mm 864935
12mm 864936



Blank Hv. gull (585)
9mm 864873



**Magnet
Blank gult gull 585**

10mm 842189



**Magnet
Bank 585 hvg.**

10mm 18551
12mm 18552



Satinert gg 585

9mm 18520
(utgåar)

Perler

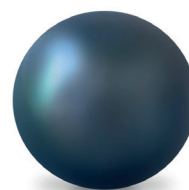

Anborede kulturperler

Størrelse	Hvit 3/4 rund	Hvit 4/4 rund	Sort 4/4 rund
mm : 3-3,5		842231	
mm : 3,5-4		842232	
mm : 4-4,5	842213	842233	842274
mm: 5-5,5	842215		
mm: 5,5-6	842216		842276
mm: 6-6,5	842217		
mm: 6,5-7	842218		
mm: 7-7,5	842219		842279

Endestykker/-kuler



Endestykker, sølv

For pålodning

3mm 864442
4mm 864443
5mm 864444

Selges i par



Endekuler

G.gull, hv. gull,
sølv og doublé

Ø3- 3,5-4,0-5,0-
6,0-7,0mm



Endekapsel

3mm
Forsølv 840020
Forgylt metall 840030

Pk á 10stk.



Endestykke, sølv

EK50
5290-EK50
-til 5mm rem

EK81
5290-EK81
-til 8mm rem

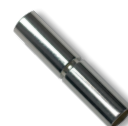

Bajonett, sølv

3,5mm
ID:3,0mm
L:19,6mm
860200

4,5mm
L: 18,5mm
860201



Endestykke m/ karabin

Sølv
SK 32: til 3mm rem
842932

SK 41: til 4mm rem
864932



Stretch Magic

Transparent strikk, 25m
0,5mm 821330
0,7mm 821347
1,0mm 821340



Tiger Tail

Nylon belagt

Perletråd vaier ca. 10m
0,31mm 821300/ 3 strands
0,35mm 208163/49 strands
0,45mm 208164/49 strands
0,53mm 208167/19 strands
0,55mm 821302/ 7 strands
0,60mm 208166/49 strands



Loctite 454

Hurtiglim, gel. Til
f.eks. liming av perleknuter i kapsel og
liming av perler.

Perletreing

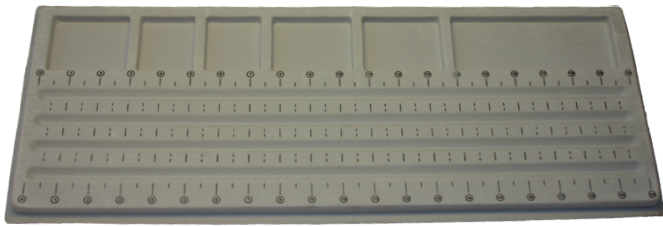

Perlesorterbrett
211185
Presset plast



Perletreingsbrett
211189
I tre, med linjal



Klemmetang
311020
Til å feste klemmer på vaier



Perletrådkutter
311200
Kraftig type med plashåndtak



Skjellakk
AL10610



Spritlampe
204670
For rødsprit, ekstra
veker finnes også.



Rivaler diamant
170485
I sett, for å forstørre hull i perler.



Korntang for perleknuter
4139AP3 - 120 mm



Korntang perleskål
145mm, 205400



Skjuleklemme
5837603
3mm kule, skjuler både
tigerhaleklemmer og
sjarner på en elegant
måte



Perlespiral
0,8mm, 1,0mm el.
1,2mm.
Forsølvet eller forgyllt.

Se også
Endestykker/
kuler
på side 3.



Klemmer
60011005C: Sølv
60021005C: Forgyllt
For vaier eller nylon
0,5mm innvendig.



Klemmer
1575290: Forsølvet
1575200: Double
For vaier, metall
Pk på 10 stk



Klemmer
600010: Sølv
600020: Forgyllt sølv
2mm m/1mm hull,
ca 2,2mm lange



Perletråd HP
(High performance)
15 ganger sterkere enn
perlesilke. Hvit, selges
i pk på 10 vinsler.



Perletråd av natursilke
2m med nål i én ende.

Hvit selges
i bunter på
10 vinsler.

Lys rosa

Mørk rosa

Korallrød

Rød

Granatrød

Gul

Mørk gul

Mellomblå

Mørk blå

Lilla

Ametyst

Turkis

Jadegrønn

Grønn

Karneol

Beige

Brun

Grå

Sort



Perletråd
Ekstra lang
4meter, hvit.

Deler til bunadssølv



SE 18



SE 114



SE 201



SE 301



SE 502



Topper

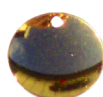

Løv runde
5mm, 7mm, 10mm, 12mm,
14mm el. 15mm. Forgylt
el. sølv. Pk på 10 stk.



Løv skjje
7mm el. 11mm
Forgylt el. sølv.
Pk på 10 stk.



Løv ende
Forgylt el. sølv.



Løv runde m/ trådkant
Forgylt el. sølv, 14mm,
pk på 10 stk.

Lommeurkjeder



Panser, rund
840690, sølv
Lengde 25 cm
Bredde 5 mm

Panser, rund
840620, chrome
Lengde 25 cm
Ø 1,7mm



Anker
840629, sølv
Lengde 25 cm
Ø1,5mm

Anker
840626, chrome
Lengde 25 cm
Ø 1,7mm

Anker
840627, chrome
Lengde 30 cm
Ø 1,7mm



Panser, flat
840622, chrome
Lengde 30 cm
Ø1,7mm

Panser, flat
840621, chrome
Lengde 25 cm
Ø1,7mm



Panser, rund
840640, dublé
Lengde 30 cm



Anker
840628, dublé
Lengde 25 cm
Ø1,7mm

Kjeder i meter

Selges i hele meter, minst én meter.



**Ertekkjeder i sølv,
blank eller lett oksidert**



E-30: 1,65mm
E-35: 2,2mm
E-40: 3,0mm
E-50: 3,5mm
E-60: 5,0mm
E-65: 5,5mm
NB Håndlaget!

Ankerkjeder i sølv



A-50: ca 2mm
A-60: ca 2,5mm
A-70: ca 3mm

Kautchuk



Naturgummi,
3mm, 4mm,
5mm og 8mm.



Ertekkjede brukt til bunad

Creoler



2mm tykke

02234: 15mm diameter
02235: 20mm diameter
02236: 25mm diameter
02237: 30mm diameter
02247: 40mm diameter
02248: 50mm diameter

Ferdige kjeder

Stål

1 rad med bajonettlås

38cm, 40cm, 42cm, 45cm.

5 rader med bajonettlås

38cm, 40cm, 42cm, 45cm.

10 rader med bajonettlås

38cm, 40cm, 42cm, 45cm, 50cm, 60cm.

30 rader med bajonettlås

38cm, 40cm, 42cm, 45cm, 50cm, 60cm.

2-farget stål/ forgylt

5 rader med bajonettlås

38cm, 40cm, 42cm, 45cm.

10 rader med bajonettlås

38cm, 40cm, 42cm, 45cm, 50cm, 60cm.

30 rader med bajonettlås

38cm, 40cm, 42cm, 45cm, 50cm, 60cm.

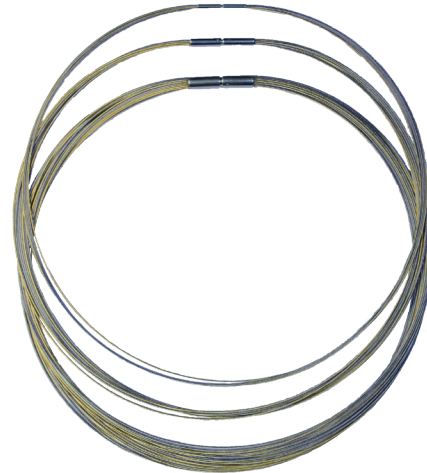

Sølv

Halvstive blanke kjeder
med karabinlås

OMR 120

1,2mm tykk. 36cm, 38cm, 50cm.

OMR 170

1,7mm tykk, 38cm (867310), 40cm, 42cm,
45cm, 50mm.

OMR 220

2,2mm tykk, 40cm, 42cm, 45cm.

OMR 300

3mm tykk, 38cm, 40cm.

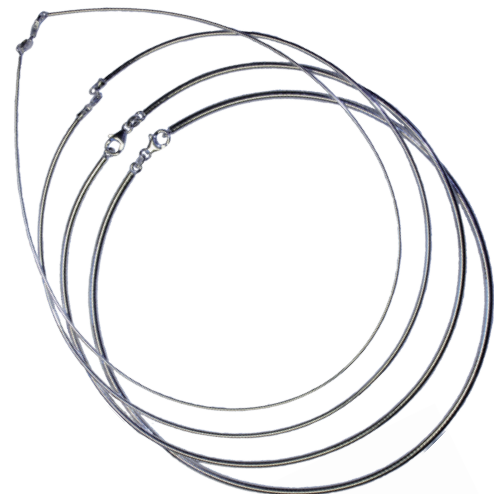

Kautchuk

2 mm med bajonettlås i sølv

38cm, 40cm, 42cm, 45cm.

3 mm med bajonettlås i sølv

42cm, 45cm.

4 mm med bajonettlås i sølv

42cm, 45cm.

Skinn

2 mm sort med bajonettlås i sølv

42cm, 45cm, 50 cm.

3 mm sort med bajonettlås i sølv

42cm, 45cm, 50 cm

2 mm brun med bajonettlås i sølv

42cm, 45cm.

3 mm brun med bajonettlås i sølv

42cm, 45cm.



Ørehullsystem

inverness[®]
Safe & Gentle Ear Piercing



Forgylt (24K) kirurgisk stål

- 10C** 3mm kule
- 11C** 4mm kule
- 12C** 5mm kule
- 30C** 5mm rosa cz
- 31C** 5mm krystall
- 39C** 3mm lys rosa cz
- 40C** Perle m/4 klør
- 82C** 3mm Ametyst
- 84C** 3mm krystall
- 86C** 3mm Alexandrite
- 89C** 3mm Safir
- 90C** 3mm mørk rosa
- 840C-1** Rosa emalje

Kirurgisk stål

- 13C** 4mm kule
- 112C** 3mm firkantet cz
- 119C** Blomst Safir/krystall
- 187C** Marihøne
- 578C** 4mm krystall-ball
- 848S** Sommerfugl

585/14K gull

- 2E** 4mm kule
- 7E** 3mm Krystall

Titan

- 16E** 4mm kule
- 17C** 4mm krystall
- 18C** 4mm Aquam.

Vi har også prøveskudd, prøve-”ører” og speil.



Pistol og merkepenn



Alkohol-pads 100stk



Display med halve par



Ear care solution 60ml, for videresalg

Easy Piercy©



•Kort leveringstid •Spreke design •Mye ekstrautstyr

	Rustfritt stål forgylt				Rustfritt stål				Titan 4mm		
Klassiske 4mm:	0590004	0590013	0590020	0590049	0591000	0591002	0591004	0591009	0598000	0598001	
	0590001	0590008	0590024	0590006	0591020	0591049	0591003	0591024	0598002	0598003	
Klassiske 3mm:	0592000	0592004	0592003	0592009	0593004	0593010	0593001	0593011	0598004	0598005	
Blomst 5mm:	0596019	0596016	0596014	0596013	0595018	0595019	0595013	0595014			
Buttons bilde 5,5mm:	0597017	0597018	0597023	0597013	0591014	0591015	0591016	0597019	0597020	0597021	0597022
	0597024	0597025	0597040	0597041	0597042	0597043	0597044	0597045	0597046	0597047	0597048
Buttons flagg 5,5mm:	0597031	0597026	0597027	0597028	0597029	0597030	0597032	0597033	0597034	0597035	0597036
Buttons stjernetegn	0597001	0597002	0597003	0597004	0597005	0597006	0597007	0597008	0597009	0597010	0597011

Dette er bare et lite utvalg. For hele sortimentet: se vår nettbutikk: nettbutikk.maxkleiser.no



Stopper-avtager
Nr. 500990



Øvelseskort
Nr. 501017,
10 i pakken.



Rensegelé
Nr. 500896,
25 i pakken.



Antiseptiske servietter
Nr. 500997, 100 i pakken.



Hansker str M
Nr. 500113,
100 i pakken.



A4 Diskdisplay
Nr. 501032



Display med øredobber
Nr. 501051, 18stk.



Merkepenn
Nr. 0500996



Lite startsett
Nr. 0599896



Stort startsett
Nr. 0599900

Begynne med Easy Piercy? Vi har startpakker og profesjonelle pakker hvor mange varer er inkludert i prisen. -Ta kontakt!

Tenger



6764
Rettavbiter
Bergeon



208172
Sideavbiter
Lindstrøm 8160
0,4-2,0mm kobbertråd.



208171
Sideavbiter
Lindstrøm 8150
0,3-1,6mm kobbertråd.



208177
Sideavbiter
Lindstrøm 8130
0,2-1,25mm kobbertråd.



208183
Skråavbiter
Lindstrøm 7290
0,35-1,25mm kobbertråd.



208180
Flattang
Lindstrøm 7490



208181
Spiss flattang
Lindstrøm 7893



208184
Spiss flattang
Lindstrøm 7890



208182
Bøytang
Lindstrøm 7590



208190
Spiss flattang, rillet
Lindstrøm 7891



208140A
Spiss flattang
Økonomi

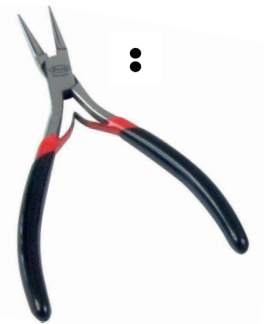

208130A
Bøytang
Økonomi



208070A
Sideavbiter
Økonomi



208120A
Flattang
Økonomi



206790
Ringbøytang



Parallelltang
212624 Glatt
212602 Med riller
212600 med spor

Tenger



207931A
Sjnetang flat/halvrund
Økonomi



207941A
Bøytang motsatt kjeft
Økonomi



207936A
Bøytang flat+rund
Økonomi



125197
Sjnetang stor
med motsatt kjeft



206821
Remhulltang



208150A
Lenketang
flat+spiss 208150A



208157
Lenketang
Spor i tuppen for å korte
strekkenker. 350009



3041099
Ringsagtang
Bergeon
Vi har også løse blad.



206780
Ringsagtang
Økonomi
Vi har også løse blad.



206785
Ringsagtang
for stålringer.
Vi har også løse blad.



211815
Remhulltang
For ekstra hull i skinnremmer



202120
Blikksaks rett

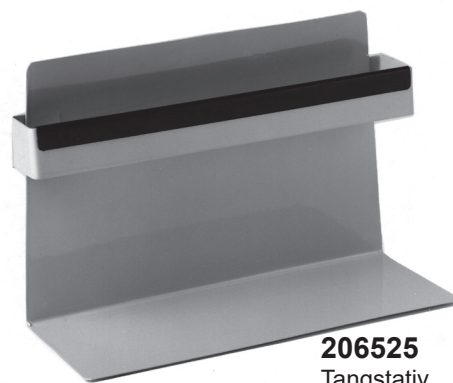

206525
Tangstativ

Korntenger



164301
Dumont Nr 1



01035
Dumoxel Nr 5



01027
Dumont Nr 7
INOX



7029FT
Korntang isolert
Dumont



0304ET2
Korntang Dumont
ergonomisk



217102
Arbeidstang
Nr.2
Antimagnetisk.



217103
Arbeidstang
Nr.3
Antimagnetisk.



217105
Spiraltang
Nr.5
Antimagnetisk.



7029F
Visertang
Nr. F



7029FT
Visertang
med teflon.
Nr. F



216450
Korntang med trespisser

216452
Løse trespisser



12713
Korntang med
karbonspisser



220340
Korntang Regine
Bronse Nr. P5



220330
Korntang Regine
Messing Nr. S5



1064AM
Korntang messing

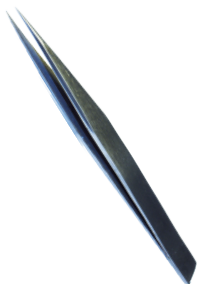

204360
Korntang AA
125mm

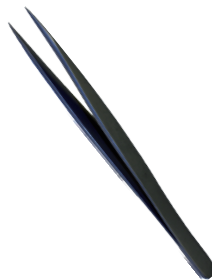

4114130
Titan korntang
125mm



212660
Titan korntang bøyd
165mm



4130B
Korntang med skyver
160mm

Luper



4422
Arbeidslupe
Styrke x2,5, x2,8,
x3,3, x4,0, x5,0 og
x6,7



2611
Lupe med hull
for antidugg.
Bergeon, finnes i
mange styrker.



1458A
Lupe stenhull
Styrke x12
eller x15



209512
Brillelupe m/klype
finnes i mange
styrker.



1492
ARY brillelupe
Flere styrker
Høyre og ven-
stre



219609
BECO brillelupe
Flere styrker,
høyre og
venstre



211990
Lupe x10
Linse Ø 18 mm

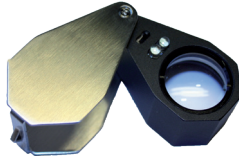

4258LED
Lupe x10
med led-lys.



5461
Lupeholder

2405
Lupeholder
med bred fjær



207665
Optivisor x2,5 styrke

Ekstra:
207670 Løse glass nr. 7 (x2,75)
207671 Løse glass nr. 10 (x3,0)

Hammere



204233
Gullsmed-
hammer



204202
Urmaker-
hammer



204253
Sisselør-
hammer



365060
Treklubbe
60x30mm.



202833
Messing/plast
med skaft i
aluminium



30417
Messing/plast



207580
Nylon-
hammer
22mm



3814A30
Plast-
hammer

Annet verktøy



211331
Fattedor rund
3 - 10 mm

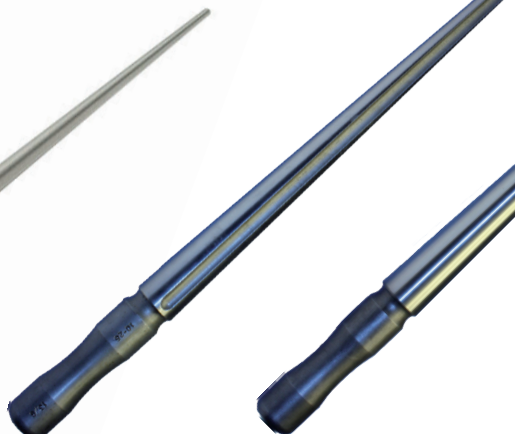

205622
Ringdor
10 - 25 mm



205632
Ringdor m/rille
10 - 25 mm



307300
Ring stuk og strekk
For glatte ringer, Med ringmål

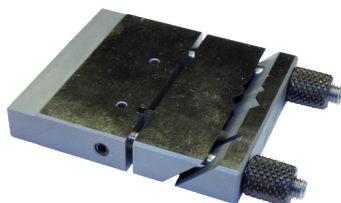

6499
Bergeon
Sjanerkutter

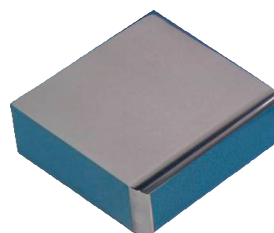

202841
Brettambolt
60 x 60 mm

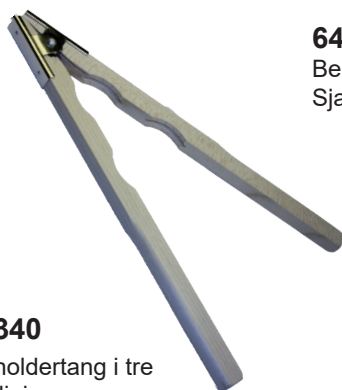

210340
Ringholdertang i tre
For sliping og
polering innvendig
i ringer



212225
Automatkjørner



Stempler
Rette og knestempler med
585, 925 og 333. 0,75mm.



Rivalholder:
206357: 2 kjokser: 140mm, 0-5,0 mm
206353: 2 kjokser: 100mm, 0-2,8 mm
206350: 2 kjokser: 70mm, 0-1,5 mm
206370: 1 kjoks: 110mm, 0-ca 0,8 mm



203825 Polerstål
203827 Polerstål med skaver



205489
Rivaler i sett



208620
Universalskaft

Måleinstrumenter



**Skyvelær
digitalt**
212300: 160mm



**Standard
skyvelær**
208710: 150mm



Fjærmål
208700
For måling av tykkelse
0-15mm, 150mm lang



Ringstokk
Bergeon 5235
Godkjent av NGF



Armringsstokk
205623
Omkrets: 120-220 mm
Høyde: 272 mm



Armringsmål
212680
Stål, 15-22 cm



Armringsmål
6259
Ø 38,1-55,5mm



Ringmål
1311-A
Standard bredde 3mm,
godkjent av NGF



Ringmål
4286
Ekstra bredde 7mm,
godkjent av NGF

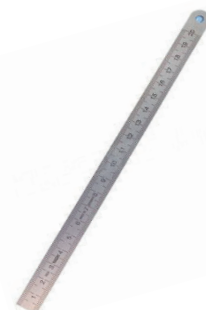

Linjal
208680: 20cm



Diamantmål
301533
Med tabell for
beregning av vekt



Diamantseller
212344
Verktøy for å vise
kunden forskjellige
diamantstørrelser



Ringmål
205605
Bredde 4,5mm, halvrund innvendig.
37 ringer fra str. 40 til 76



**Ohaus 5593SJX622M
Godkjent vekt**
0,1-620 gram.
For kjøp og salg av gull,
EU-kalibrert og
godkjent av Justervesenet.



**Lommevekt Tanita
1479Z**
5020-313999
MAX 200 gram.
H/B/D: 100,0 x 760,0 x 157,0
mm
Ikke godkjent for kjøp
og salg av gull.

Bor og freser



203
Spiralbor standard
 Med 2,35mm Ø tange,
 0,5 til 1,4 mm

HSS
Spiralbor hardmetall
 Med 2,35mm Ø tange,
 0,6 - 2,0 mm

DIA203
Diamantbor
 Med 2,35mm Ø tange,
 Til f.eks. perle- og steinboring.
 0,8 0,9 1,2 og 1,4mm.



Nr 1: Kulefres (1,0 til 8 mm)
Kulefres HSS (1,0 til 2,3 mm.)
Nr 36: Sylindrefres (0,8 til 3,1 mm.)
Nr 38: Sylindrefres kon (0,6 til 2,3 mm.)
Nr 413: Fattefres (1,0 til 6,0 mm.)
Nr 469: Hulfres: (0,9 til 3,1)
Nr 485: Linsefres: (0,7-4,5 mm.)
Nr 256: Hulfres med spor (0,8-2,3 mm.)

Sager, blad og filer



20354
 Ansatsfil 6" - hugg 1 - 6

20361
 Halvrund fil 6" - hugg 1 - 6

20363
 Ringfil 6" - hugg 1 - 4

Nålefiler



Fasong	Hugg. 2	Hugg. 3	Hugg. 4	Hugg 5	Hugg 6
Tunge	286108		286162		286159
Rund			286132	203887	
Kviv	2405-160			203888	
Flat	286100		286102	203751	
Barett	286136			203881	
Halvrund	203776		286154	203757	
Trekant	286118		286120		286176
Firkant	286186		203756		
Flat spiss			286114		



6651
 Sagblader Bergeon
 Nr 2, 0, 2/0, 3/0, 4/0, 5/0, 6/0.
 Pk på ett gross, = 144stk.

205652
 Sagbue 80 mm
 Leveres også i 100 mm

5020-314621
 Sagbue 75 mm
 Bestillingsvare

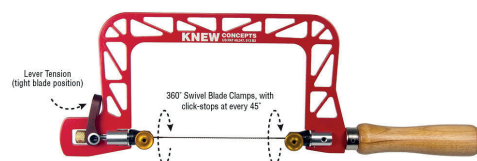

Overflatebehandling for hånd

Smergelstikker

Flat: korning 120, 240, 320, 400, 500, 600, 1000

Halvrund: korning 100, 120, 240, 320, 400, 600, 1000



Gummismergelstikke

1x2x20cm 150HP
5420-SC150HP



Gummismergel

med treskaft, korning 120

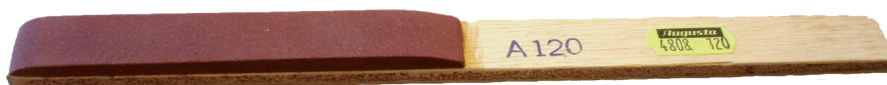

Kratsebørste

Messing, 4 rader

202931

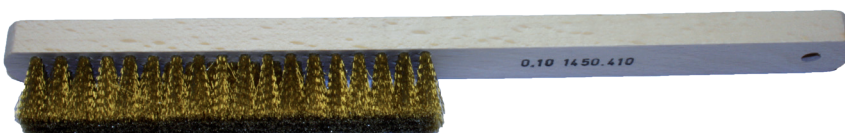

Pusse kloss 80x50x20mm

Korning:	60	213300
	120	213302
	240	213301



Mattepute

11,5x29cm,

48181: Fin

48183: Grov



Smergelpapir og smergellærret

23 x 28cm, Korning 100, 120, 180, 240, 280, 320, 400 og 600.

Overflatebehandling med poleringsmaskin



202960
Kratsebørste
3 rader - 80mm
202970
Kratsebørste
4 rader - 100mm



Satiflex matteskive Alum. oxyd.
Ø 110
203187: Fin
203188: Veldig fin
203189: Ultrafin



Satiflex mat-teskive Siliz. karbid.
Ø 110
203210: Grov
110x30x3mm A/C Stor
203211: Middels
110x30x6mm S/M. Stor
203212: Fin
110x30x6mm S/F. Stor



Artifex gummiskive:
212406:
100x20 mm korning 400
212412:
100x20 mm korning 250
212410:
100x20 mm korning 150
212409:
100x20 mm korning 80
212417:
100x10 mm korning 150
212418:
100x10 mm korning 80



Mattebørste 209560A:
Tråd 0,20 mm - Gul
209561A:
Tråd 0,30 mm - Rød
209563A:
Tråd 0,45 mm - Blå
209562A:
Tråd 0,60 mm - Grønn



Lerretskive
Gul, sydd
45750: 4"
45751: 5"
45752: 6"



203077
Slipebørste
Ø 80 mm - spiss



1484208
Slipebørste
Ø 80 mm - flat



Geitehårsbørste
Ø 49 mm
203101: Sort
203102: Hvit

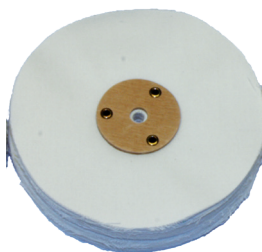

Lerretskive
Hvit, usydd
203191: 4"
203192: 5"
203193: 6"



45760
Lerretskive 4"
Ekstra myk



456729
Lerretskive 4"
Flanell



456750
Ullhjul 50 mm
456760
Ullhjul 60 mm
203139
Ullhjul 100mm



45673
Ullhjul 80 mm



455675
Filtrigle



1494A
Ullrigle



456390
Filtskive



53M/203000
Kratserigle



Artifex 212421
Rigle korning 150



4557/203260
Filtrigle med skive



Polertape
Leveres i bredder fra 2 til 20 mm

Husk å bruke vernebriller!

Overflatebehandling med micromotor

Silikon med slipemiddel, uten tange:

Hvit: grov

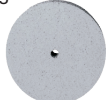

Skive
ca 22x3mm



Linse
ca 22x4mm



Sylinder
ca 7x20mm



Tykk sylinder
ca 12x20mm

Sort: middels



Skive
ca 22x3mm



Linse
ca 22x4mm



Sylinder
ca 7x20mm



Tykk sylinder
ca 12x20mm

Blå: fin

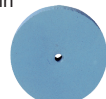

Skive
ca 22x3mm



Linse
ca 22x4mm



Sylinder
ca 7x20mm



Tykk sylinder
ca 12x20mm

Rosa: ekstra fin



Skive
ca 22x3mm



Linse
ca 22x4mm



Sylinder
ca 7x20mm



Tykk sylinder
ca 12x20mm

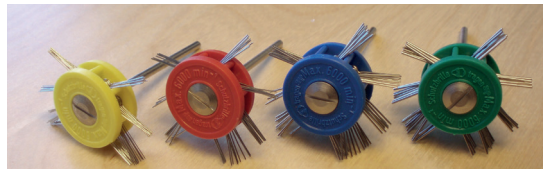

Mattebørster i stål, for grovmatting

Gul: 0,20mm, rød: 0,30mm, blå: 0,45mm, grønn: 0,60mm.
Jo tykkere tråd, jo grovere matting. **NB! Husk vernebriller!**



Mandril
3mm splittet,
parallell
290912



Mandril
4mm splittet,
parallell
291690



Mandril
314: splittet,
kon
5020-314



Mandriller
305: Med skrue
301: med gjenger



Silikon m/tange

2stk i pakken

285490: hvit, grov
285438: rødbrun: fin



Geitehår

Middels, grå,
Ø22mm
208560



Geitehår

Myk, hvit,
lang bust,
Ø22mm, 208584



Geitehår

Myk, hvit,
208592



Geitehår

Myk, hvit,
Ø22mm
212570



Smørgelrull m/tange

291300 K.320
291316 K. 400
291461 K.600



Stål

HP116
212524



Messing

Børste: 208590
«Pensel»: HP104M



Syntet

Hard, sort
208583



Syntet

Hard, sort
208593



Matte- børste

212507



Filt

For slip, 208589



Garn

For polering
212528

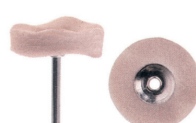

Lærret

For slip og
polering
208586



Sinn

For slip og
polering
208588

Loddeutstyr

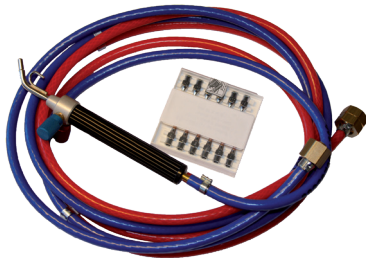

208797
Mikrobrenner loddepistol
ink. sett med dyser.



208800
Loddepistol for
luft/propan



208798
Slange og
munnstykke



208796
Loddepistol
for propan/butan.
Utskiftbar dyse.



204621
Skamolex loddeplate
30x20x1,5 cm

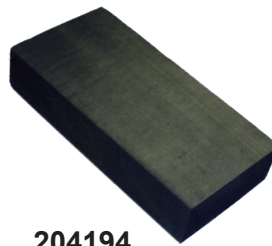

204194
Trekull
Naturkull



312080
Degussa syrekoker



4242E
Rund Skamolex
for loddekarusell

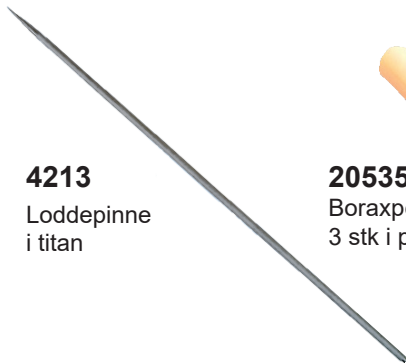

4213
Loddepinne
i titan



205351
Boraxpensler
3 stk i pakken.



204731
Loddetang
isolert, buet

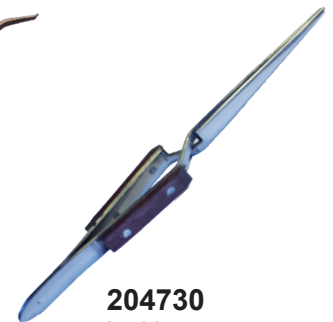

204730
Loddetang
isolert, rett



Bindtråd
203376: 0,35mm
203379: 0,50mm
203381: 0,60mm
203383: 0,70mm



AL132100
Fluoron
100 ml ferdig
utblandet flussmiddel.



4223030
Loddemiddel
Firescoff:
sprayflaske



AL137500
Syre for avkok
Vitrex, pulverform.



4210100
Steinbeskytter
Coolpaste



4209
Steinbeskytter
Metallex

Stentestere

Alle disse kan teste både løse og monterte stener.



301547
Presidium Gem Tester

Hjelper deg til å skille mellom likt utseende edelstener, raskt og enkelt. Dette apparatet kan også identifisere diamant. NB den kan ikke skille mellom naturlige og syntetisk framstilte edelstener, her må du ta mikroskop og erfaring til hjelp. Den kan heller ikke skille moisanite fra diamant.



301529
Presidium MultiTester

Skiller mellom diamant og moisanite.



301548
Presidium Synthetic Diamond Screener SDS

Diamanttester for fargeløse og syntetiske stener

Testing av gull



Prøvesyreset

207060

Innhold: 8K-14K-18K- 21-6K, sølv, prøvestein og rengjøringsvæske for steinen.



Løse syreflasker

8K /21,6K (20708..)

-angi karat-type

14K (207082)

18K (207083)

Sølv (207085)



Prøvesyrestein

204155

Størrelse: 75x50x5mm



Prøvestjerne

204160

For å lage sammenligningsstreker på prøvesteinen.



Gulltester penn "CaratScreenPen"

301555

Urmakerverktøy Skrutrekker



Skrutrekker Bergeon 30080

Leveres med en tube reserveblad

0,50 Orange	0,60 Hvit
0,80 Gul	1,00 Sort
1,20 Rød	1,40 Grå
1,60 Lilla	2,00 Grønn
2,50 Blå	3,00 Brun



Skrutrekkerblader Bergeon 30080T

0,50 Orange	0,60 Hvit
0,80 Gul	1,00 Sort
1,20 Rød	1,40 Grå
1,60 Lilla	2,00 Grønn
2,50 Blå	3,00 Brun



30081-S10 Skrutrekkerkarusell Bergeon

Sett med 10 skrutrekker



5970 Skrutrekkerkarusell Bergeon

Sett med 9 skrutrekker



Stjernetrekker Beco 2110

1,20 Grå	1,50 Lilla
2,00 Grønn	2,50 Blå
3,00 Brun	



Sett 30081CP05

5 stjernetrekker
Bergeon
1,20 - 1,50 - 2,0 -
2,5 - 3,0

6899

Løse reserveblad til
alle størrelsene

Kasseverktøy

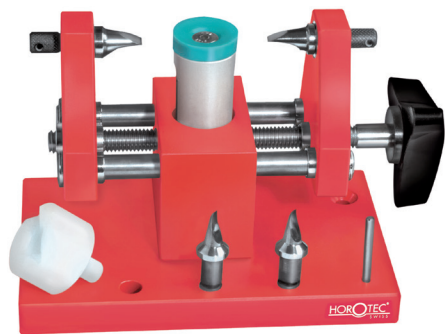

07.115 Kasseåpner



07.361 Kasseåpner



07.013 Kasseåpner Max 65mm



168.880/B6929 Kasseåpner

1668081 blad 3mm
1668082 blad 4,5mm
168800.080 spiss



6484 Kasseåpner



07.014 Kasseåpner Max 57mm

Kasseverktøy



281908 Jaxa stor
Kasseåpner max 62mm



2819M Jaxa mini
Enkel å holde

Innsatser til Jaxa:



2819-A

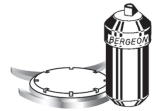

2819-B



2819-C



2819-D



210670
Kasseåpner



6987
Kassekniv.
6987-L
Reserveblad



6987-G
Kassekniv for
venstrehente.
6987-LG
Reserveblad



204060
Kassekniv



204045
Kasseåpner



7662
Bergeon kasseåpner



5500-C
Glasspressesett
Leveres i flere utgaver



311560
Profi Quick
Blokkpresse
Må ha i tillegg:
2 x 311567 (for å kunne feste innsatser)
1 x 311565 (sett m/ innsatser)



07.131
Horotech 07.131 bak-
klokkespresse med 12
innsatser
110 x 95 x 210 mm
1stk flat 45 mm lyreform
1stk 17 mm
1 stk 22/25 mm
1 stk 26/29 mm
1 stk 30/33 mm
1 stk 34/37 mm
1 stk 38/41 mm



07.117
Bezelavtager



5685 stor
Kasseholder, opp til 65mm.

5090 liten
Kasseholder, opp til 35mm.



311565
Sett med 24 innsatser til runde
og firkantede kasser. Passer
til baklokk/glass presser med
6mm gjenger som AF179140
eller Bergeon 5500.



5011
Kassepumpe.
Reservespisser på lager (Ø1,5-2,0-2,5mm)

Viserverktøy



30018
Viseravtager



30019
Viseravtager



Sett 7404
3 viserpåsettere



Viserpåsetter
7404-1: Hull Ø 0,50/1,00
7404-2: Hull Ø 0,80/1,50
7404-3: Flastspill pvc/messing

26.008
Multifunksjonsverktøy
med spisser av messing og PEEK.
Til rengjøring av tallskiver, urdeler m.m.



8935
Bergeon viserpåsetter



201629
Viserpåsetter



7982-85
Tallskivebeskytter
Beskytter tallskiven
når du tar av viserne.
Pk på 100 el. 20stk.



30636-1
Viseravtager Presto 1

Lenke- og remverktøy

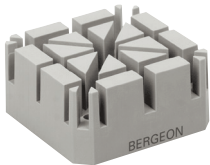

6744P
Lenkekloss
Hard plast

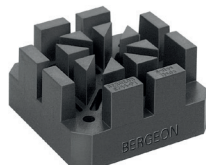

6744P1
Lenkekloss
Hard plast, brede spor



6744PS
Lenkekloss
Myk plast



6744P1S1
Lenkekloss
Myk plast, brede spor



10519
Lenkekloss

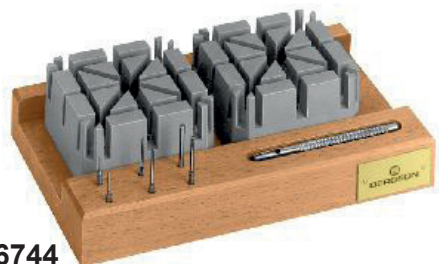

6744
Lenkekorterverktøy
Sokkel med plass til:
2 lenkeklosser 6744P
Pundselskaft
6 stifter fra 0,4 til 2,0 mm



202860
Lenkekorterverktøy
Stativ, lenkekloss,
7 stifter 0,4 - 2,0 mm
8 skrutrekkerblad



6988
Lenkekortesett ekstra lange,
5 ulike tykkelser på stiften.
0,7 - 0,8 - 0,9 - 1,0 - 1,2
Selges også løst.

Lenke- og remverktøy



7745-100

Lenkekorterverktøy komplett.
Selges også med mindre utstyr.



6745G

Stift til lenkeverktøy, 10 pk
0,4 - 0,6 - 0,8 - 1,0 - 1,5 mm



6745PG

Stiftholder til lenkeverktøy



6745/7745-PGA

Stiftholder til lenkeverktøy



1256-SR28

Sokkel til lenkeverktøy.
Finnes også i Ø 20

1256-202880

Lenkekorter fra Beco
til å skru ut/inn skruer
i lenke. Leveres med
to blader i Ø1,0mm.



6767S

Barettutstøter
Stift: Ø 0,8 mm, spade 3,0 mm



6767A

Spade 3,0 mm

6767B

Stift 0,8 mm



3153

Barettutstøter



3153A

Spade: 3 mm, 10-pk.



3153-B

Stift 0,8 mm, 10-pk.



6767-F

Barettutstøter
Stift: Ø 0,8 mm, spade 1,0 mm



7767-F

Barettutstøter
Stift: Ø 0,8 mm, spade 1,0 mm



6767AF

Spade 1,0 mm

6767BF

Stift 0,8 mm



6111

Barettutstøter



6111E

Spade 4,0 mm



6111D

Stift 0,8 og spade 1,0 mm



5680

Lenkekorter, stiftutslager
med springfjær.



220015

Barettang Dame



7825

Bergeon
barettang

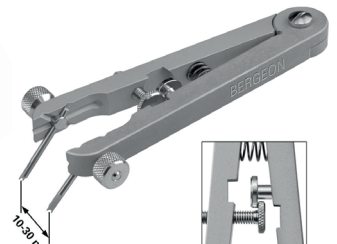

6825

Barettang

5680.99

Reservespisser



10.311

Barettbøyer



202867 stiftutstøteverktøy

med justerbar stiftlengde max 2cm.
202868 Stift 0,8 mm (pk å 2 stk)



2277

Holder til lenker for tilpassing
av endefestet.

Diverse urmakerverktøy



30097BC
Støvklokke
Ø 100 mm



4722
Støvklokke
Ø 90 mm



67596
Støvlukk plexi
Str. 200x275x60mm



30513060
Bensinkopp 60 mm

30513080
Bensinkopp 80 mm

5733
Støvblåse
60 x 95 mm



5393
Arbeidspute
80mm



5394PG
Arbeidspute
80mm



539575
Myk arbeidspute
75mm



Urmakerbørste
202870: Meget hard
202871: Hard
202872: Mellom
202874: Myk



Verkholder
4039: Dame, metall
4039P: Dame, antimagn
4040: Herre, metall
4040P: Herre, antimagn



30180A
Oljekopp



2021
Skrustikke



7013
Oljelegger
R - rød: 0,18 mm
B - blå: 0,24 mm
V - grønn: 0,32 mm
J - gul: 0,45 mm



7010/217205
Bergeon plastpinne 150 mm
En spiss og en flat ende



30102
Oljelegger
A - rød: 0,10 mm
B - blå: 0,15 mm
C - grønn: 0,20 mm
D - gul: 0,27 mm



16200
Bergeon
foringsmaskin

5701
Sett med 1500 foringer
i messing
5488
Sett med 450 foringer
i messing

Foringer selges løst i
10 pk
per nummer i messing
og bronse



30102S
Sett 4 oljeleggere

Datagravering, -it's Magic!

Datastyrt gravering er fremtiden.

Den store fordel er at det er enkelt og rask! Programmet er veldig enkelt; -kan du sende e-post og skrive i et skriveprogram, så er det lett å lære å gravere. Til og med foto!

Vi fører en mengde forskjellige maskiner som dekker forskjellige behov, du kan gravere ringe, armbånd, klokkebaklukk, smykker, og dåpsartikler. De største maskinene har også mulighet for utfresing av modeller og skilt.

-Ta kontakt for tilbud!



Magic S4 - 311829

For flat gravering og litt buet. Med kamera!

Sort "kloss" er ekstra tilbehør.

Arbeidsflate:

238 x 178 x 39 mm



Magic F20 - 311410

Flatgravering, og litt buet.

Åpen på den ene siden for å kunne ta lengre gjenstander.



F300P - 311400

For flatgravering 300x200x60mm og fresing. (Bestselger)



Magic 50 - 311430

For ringe, armbånd, flatgravering 140x100x38mm



Magic 70 - 311440

For ringe, armbånd, flatgravering 140x100x38mm, og fresing.



311345

Sett med 6 stk. små pins.



311356/311357

Sett med 5 stk pins. hhv. 1.45 mm og 60 mm



311409

Plastkuler for å feste gjenstander. Bli myke og formbare ved 65 °C. Kan brukes flere ganger.



311353

Scanner for fingeravtrykk

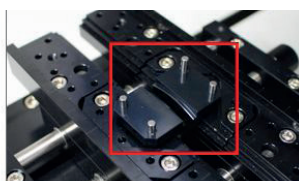

311413 (311366)

Holder for armbånd



311369

Bestikkholder

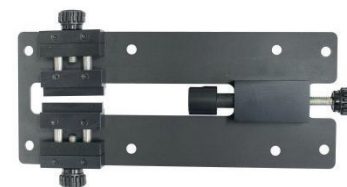

311362

Pennholder (til F300P)

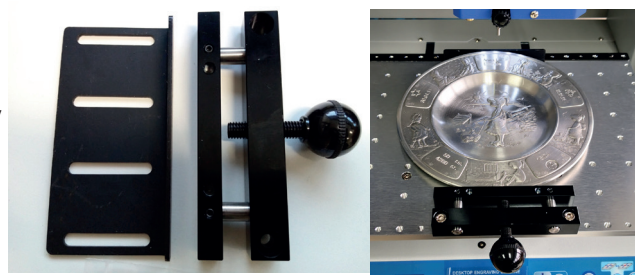

311361

Holder (til F300P) Kan benyttes til gravering av bl.a. dåpsstallerkener.

Tromling



482545
Poleringstrommel 1,5liter



482512
Poleringstrommel 4,3liter



307120
Polerkulerrens N-31
1-2dl pr l vann.



5510312
Polersåpe Otec
3% i vann

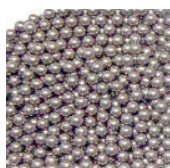

Polerkuler

Rustfrie, men må likevel alltid være dekket av vann.
Runde 2,0 mm - Runde 2,5 mm - Satellit
307117 - 307118 - 307119

Loddeapparat



301500
Microtorch
Passer til å lodde små ting som tynne ringer og kjeder. Går på lightergass.



PUK 6 m/mikroskop
311930
Loddeapparat.
Reparerer lenker og skader på stålkasser.

Bestillingsvare.
Pris på forespørsel.

Lapidering

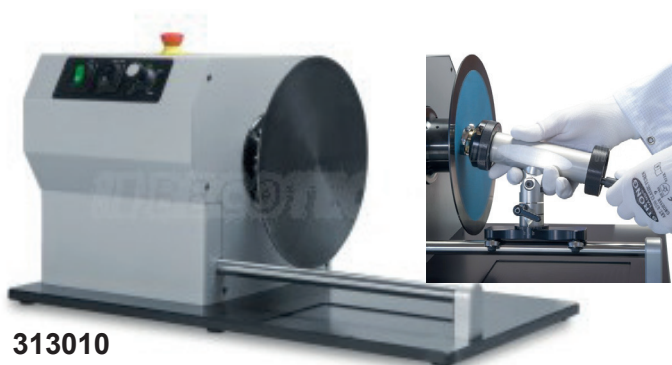

313010
Lapideringsmaskin LM1



313011
Holder LM1



313012
Bord LM1

Polering



310400
JoolTool Nytt konsept, be om info!

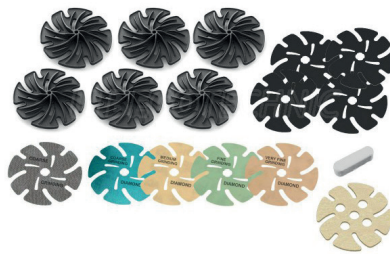
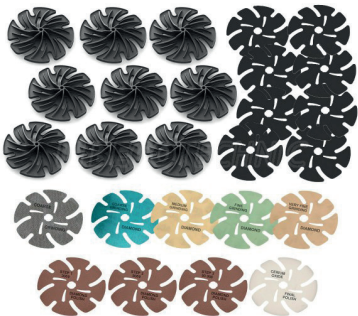

310401
JoolTool sett med skiver.
Lapidere harde og myke
stener. Riper i safirglass

310402
JoolTool sett med skiver.
Lapidere myke stener.

310408
JoolTool sett med skiver
For myke metaller

Skiver finnes i mange ulike sett og selges også løst



313660
Polistar Mini
2 hastigheter, lys og avslug.



310961
Polimaxx 1
Trinnløs 300-3000rpm
lys og avslug.



310962
POLERMASKIN POLIMAXX II
Med nødstop, 300-3000RPM
2 spindler

Rens og tørk



313305
Rensemaskin
ACS 900 m/ultral lyd



313557
Rensemaskin
Elmasolvex RM



313536
Steamrener
Lager damp 4 bar.



313520
Steamrener
Lager damp 4,5 bar.



Elmasonic Xtra TT
30H 2,0L 314268
120H 10L 314270



Elmasonic Select
30S 2,7L 314710
40S 3,9L 314711
100S 9,5L 314714



Elmasonic Easy
10H 0,9L 314341
30H 2,7L 314346
40H 3,9L 314348



314226
Lokk til S100

314176
Lokk til S30



314261
Fleksible kroker til ultralyd



313393
Rund metallkurv
Ø 60 mm



313371
Rund plastkurv
Ø 74 mm

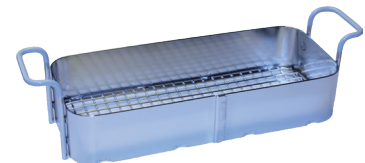

314157
Metallkurv til S100

314177
Metallkurv til S30

314227
Metallkurv til S100



314504
Elmadry tørketank 1,9 l
Blåser luft med romtemperatur eller inntil 70°C.
Slår seg autmatisk av ved høy temperatur



314506
Elmadry
tørketank 9l.

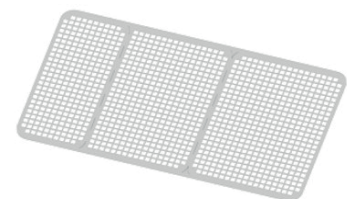

314502
Silikonmatte til bruk i tørketank.
To størrelser. Kan klippes til.

Trykktesting



313429
Trykktester Proofmaster
Tester vanntetthet på inntil 10 atm.



672000
Kompressor Planet-Air
Gir et makstrykk på 16 bar



Skriver 313870
Skriver til Proofmaster



Skriver 313885
Martel, til trykktester



Fargebånd
313911: Citizen
313994: Epson
313996: CBM



311503
Trykktester Natator 125
Tester vanntetthet på inntil 125 bar.
Uten strømtilkobling.
Tank: Ø80 mm, høyde 65 mm



313816
Papir til printer
Chronoproof.

313997
Papir til printer CBM-
910 eller 313995.

313987
Thermopapir til
Martell skriver 313989.

Støvsuger og varmluft



306146
Støvsuger komplett med
fotpedal, slange og børste.
Mål 205 x 185 x 150.



307011
Varmluftpistol AT852D
For å varme kasser, bl.a. for å ta ut
glass som er limt.

Testing av urverk



313780
Witschi Chronoscope X1
 Reguleringsmaskin for mekaniske ur

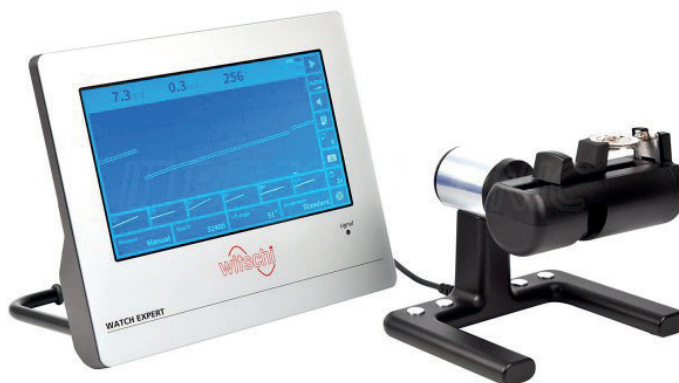

313777
Witschi Watch Expert 4
 Reguleringsmaskin for mekaniske ur

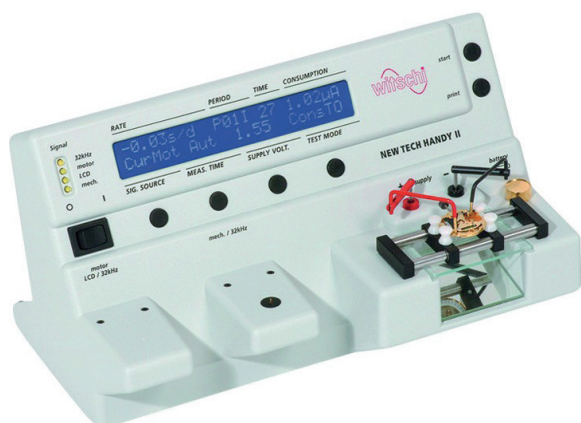

313960
Witschi New Tech Handy 2
 Testing av kvartsur,



313898
Witschi Analyzer
 Testing av mekaniske og kvartsur.



309100
Elma Cyclomotion
 Testing av inntil 24 ur



309185
 Beco urtester for 4 ur



19115
 Multitester

Avmagnetisering



313940
Witschi Teslascope
Får å måle magnetisme og avmagnetisere klokker

313930
Witschi Cyclonic
For å måle batteri, sjekke puls, kjøre løpeverket/stepmotor



306093
Elma Antimag
Får å måle avmagnetisere klokker etter service

6000080
Renata batteritester, måler også pulser



Motorer



304916
Micromotor Badeco M3ASF440
Solid mikromotor for profesjonelt bruk, produsert i Sveits. Inkluderer kontrollboks, håndstykke med "quick change"-system, fotpedal og holder.



304900
Micromotor Osada Success 40
Robust mikromotor for profesjonelt bruk
Hastighet: fra 1000 - 40000 rpm



311645
Micromotor Xenox
Rimelig mikromotor
Hastighet: fra 5000 - 20000 rpm



312317
Håndstykke
Universal

305096
Hengemotor HM2000
Hastighet 124000 rpm



Galvanisering og oksidering



KGA 200
Galvanoanlegg
250 x 475 x 320 mm
med temperaturkontroll
311590



311660
RMGO rhodineringsanlegg
En rimelig og enkel løsning



3040400103
Avfetting
50g, blandes i 1l
destillert vann.
Brukes ved 20-25°
og 7-8V i ca1min.



3100101903
Forgylling
for elektrolyttisk
forgylling.
Pulver, blandes i 1l
destillert vann. In-
neholder 1g gull.
Brukes ved 60-70°
6-8V i 20-30sek.



4040110102
Pariseroxid
100ml flaske.



3110200101
Rhodinering
100ml, blandes i
1l destillert vann.
Inneholder 2g rho-
dium.
Brukes ved 20-25°
og 2,1-2,3V i ca 2
min.

Diverse



217519
Eschenbach
Stereo mikroskop
Med solid bordfeste.
forstørrelse 10x og 20x



307685
Zeiss Stemi 305 EDU
Mikroskop



2020-S / 218287
Steriliseringsboks
Boks egnet for å kunne sterilisere
mange ulike produkter, for eksempel
smykker, ur, verktøy, forbruksvarer,
briller o.l. Benytter UVC-LED til å
drepe 99,9% av bakterier på kun 3
min.

Bord og utstyr



309740 Ergonomisk urmakerbenk

Elektrisk høydejustering og 2 skuffesøyler
 Innfelt riflet plate for bl.a. skrustikke. Hull for trykkluft-
 og vakuumslinger eller kabeluttak.
 Integreert lampeholder for alle vanlige Waldmann
 arbeidsbenkarmaturer.



309653

Overtrekk

Svart mikrofiber. Til bord 210x140 cm



313175

Arbeidslampe Waldmann med lupe.

En perfekt kombinasjon av optimal
 forstørrelse og høy lyskvalitet!



307735

Arbeidslampe Waldmann

Ferrarien blandt arbeidslamper!
 Gir et homogent godt lys uten
 gjenskinn og skygge. Bruker LED.
 Utrolig bra å jobbe i!

19765

UV-lampe
 For glass



7808

Arbeidsbordplate antiskli

320 x 240 x 2 mm
 78081: Grønn
 78082: sort
 78083: hvit



309651

Arbeidsbordplate
 Passer bord 309620



6808-V

Arbeidsbordplate, grønn

6808-B

Arbeidsbordplate, hvit



309650

Arbeidsbordplate
 fasongformet,
 passer bord 309621.



7871

Magic wiper

Magnetlist som gjør det enklere
 å finne igjen deler på gulvet.



207405

Matte for verktøy
 10 x 15 cm

Oljer og fett



9010/2
Moebius
Synt-a-lube
2 ml



9020/2
Moebius 9020
Synta visco lube
2 ml



9101/2
Moebius
Syntetisk
HP 500
2 ml



9102/2
Moebius
Syntetisk
HP 750
2 ml



9103/2
Moebius
Syntetisk
HP 1000
2 ml



9104/2
Moebius
Syntetisk
HP 1300
2 ml



941/2
Moebius
for ankerstener
2 ml



8040/20
Moebius
Veggursolje
20 ml



8200/20
Moebius 8200
Lubrifiant
20 ml



8300/20
Moebius 8300
Remvellefett
20 ml



9415/2
Moebius
Syntetisk fett
2 ml



9504/05
Moebius
Barrel grease
5 ml



8941/100
Moebius
Fixdrop
100 ml



8513/10
Moebius
Silikon (Fast)
10 ml



6945/20
Fomblin fett
20 ml



28001
Fomblin
Silikon



211385 / 7055
Silikon smøreboks

Lim



211570
Lim for min. glass
UV Minefix



1691680
Loctite
hurtiglim



208406
UHU-2komponent lim 30ml



26520
Loctite skruelim
10 ml



208230
Loctite skruelim
5 ml



101080
Elma Vacu-proof
Flytende silikon
20 ml

Slipe-og poleringsmiddel



Dialux

Rød: Høyglanspolering av gull
 Hvit: Polering av sølv.
 Grå: Finpolering av rustfritt stål
 Grønn: Polering harde legeringer
 Orange: For bløte materialer
 Blå: Høyglanspolering av sølv og hvite metaller.



5410-208808
 Menzerna grå
 Slipemiddel, 1,45 kg
 Før polering.



193125
 Unipol polermiddel
 For alle metaller.



AL19020 Diamantine

Pulver, til polering av ting som f.eks ikke tåler vask/rens. Også fin til å jevne ut fargen på oksidering.



Poleringspakke

Innhold:
 1 hvit lærrettskive myk
 1 gul lærrettskive stiv sydd
 1 hvit Luxor 100g for gull, sølv og rustfritt stål
 1 gul Luxor 100g for alle metaller, superfinish

Diverse kjemi



7007S
 Bergeon sett med 140 rengjøringssticks



210845
 Trykkluft



210849
 Elektronikkspray



211160
 Polywatch to-komponent middel for polering av urglass



70331
 Rodico



60331
 Rodico grønn

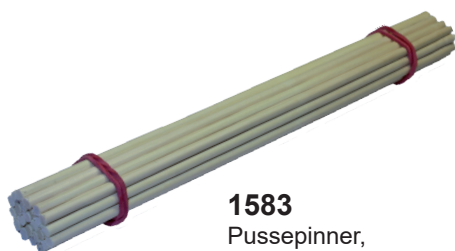

1583
 Pussepinner,
 2 - 2,5 - 3 - 4 -
 5 - 6 mm



0256
 Kratsebørste messing.
2834LS
 Refill



0257
 Kratsebørste glassfiber.
0259
 Refill

Heli-produkter o.l.



113026
Heli pusseklut ur
XXL 30x24mm
Selges i stykk.



113027
Heli pusseklut universal
Selges i 10pk.



141285
Heli pusseklut for smykker
Selges i 10pk.



141286
Heli pusseklut for sølv-smykker
Selges i 10pk.



141299
Heli pusseklut for smykker 4 i 1.
Selges i 12pk.
Turkis for rengjøring av perler og stener
Lys grå for overflatepolering
Lilla for rengjøring av gull
Mørk grå for rengjøring av sølv



141300
Heli pusseklut for ur 4 i 1.
Selges i 12pk.
Rosa for rengjøring av steiner
Lys grå for overflatepolering
Lilla for rengjøring av gull
Off-white for rengjøring av stål og krom



4657.S2
Sølvkluter S2-N
Selges i 20pk.
Individuelt pakket i poser for videresalg.
Assorterte farger.



141265
Heli Deo Spray
For skinn-remmer.
Selges i 12PK.
25 ml



141266
Heli lenkerens
Selges i 12PK.
25 ml



141278
Heli gullrens
150ml
Selges i 12pk.
Kun til gull.



141279
Heli sølvrens
150ml
Selges i 12pk.
Kun til sølv.



141280
Heli juvelrens
150ml
Selges i 12pk.
Rengjør edelstener.

Ikke egnet for rengjøring av sølv, andre metaller, perler og koraller.



141284
Heli gull- og sølv skum
Selges i 10PK.

Perfekt for enkel pleie av gull- og sølvsmykker.
100ml.



141061
Heli Smykkerens, skum
Selges i 12PK.

Spesielt laget for rengjøring av smykker som har sorte detaljer.
100 ml.



141303
Heli smykkerens m/pads

Innhold: 3 stk. pads
Selges i 12pk.

Egnet for alle typer smykker som gull, sølv og rustfritt stål med perler eller edelstener.

Les mer på nettsiden vår.



141304
Heli smykkerens-pads

Innhold: 10 stk. pads
Refill til 141303.

Egnet for alle typer smykker som gull, sølv og rustfritt stål med perler eller edelstener.

Les mer på nettsiden vår.



101363
Heli ultralydrens, konsentrat
Selges i 4pk.

Konsentrat for rensing av smykker i ultralyd.
Blandingsforhold 1:20.



314141
Heli ultralydkar 600ml

For rensing av smykker i ultralyd. Benytt Heli ultralyd-konsentrat.

Egnet for rengjøring av smykker av alle slag, briller, rekvisita til kontaktlinser og klokkelenke.

Arbeidstøy



Heli hansker, mikrofiber
Hvit
Selges i 10pk.

204750: Small
204751: Medium
204752: Large
204753: Extra large



Heli hansker, mikrofiber
Sort
Selges i 10pk.

204754: Small
204755: Medium
204756: Large
204757: Extra large



Poleringshansker
Meget god passform, silikonforsterkede tupper. 6 par i pakken
203229: Størrelse 6
203230: Størrelse 7
203231: Størrelse 8



Fingersmukker
Neopren
Ekstra varmebeskyttelse.
5243N2: Oransje: str S/M
5243N3: Blå: str M/L
4stk i pakken



211976
Fingersmukk
Skinn,
No.3/M



Fingerbeskyttere
211956: str M
211957: str L
211958: str S



312281
Støvmaske
FFP2



312261
Vernebrille
Kunststoff

Arbeidfrakk
Bestillingsvare

Sikker beskyttelse mot elektrostatisk ladning. Stoffet består av 66 % polyester, 31 % bomull og 3 % ledende garn i en stigning på 4 mm.

Skjult trykknapp lukking hele veien
Kan vaskes i maskin opp til 60 °C

Str:XL: 1230-220624
Str: 2XL: 1230-220692



Rensevæsker



1270-112
#111 Rensevæske m/ ammoniakk
Til armbåndsur.
3,8 liter
Best egnet med 121 Skyllvæske. Men passer til alle L&R skyllevæsker og til bruk m/ ultralyd.



1270-115
#566 Rensevæske u/ ammoniakk
Til armbåndsur/ lommeur.
3,8 liter
Passer til alle L&R skyllevæsker og til bruk i ultralyd.



1270-118
#3/118 Skyllevæske.
3,8 liter.
Inneholder ingen benzol eller klorløsningsmidler.
Legger ingen fet film igjen på overflater.



1270-121
121 Hurtigtørkende Skyllevæske.
3,8 liter.
Inneholder ingen benzol eller klorløsningsmidler.
Legger ingen fet film igjen på overflater.
Passer best sammen med rensvæske #111



1270-134
#134 Rensevæske med ammoniakk
Til veggur og vekkerur.
3,8 liter
Blandes med vann 1:7



2552
Bergeon
One-dip solution
Spiralrens.
50 ml



5410-170
Rensevæske med ammoniakk.
For bruk i ultralyd rensetank., Ekstra effektiv.
3,8 liter.
Konsentrat, blandes med vann 1:7.



5410-273
Rensevæske uten ammoniakk.
For bruk i ultralyd rensetank. Lukt svak
3,8 liter.
Konsentrat, blandes med vann 1:10.



5410-295
Smykkerens Jewelry Clean Deluxe, for videresalg.



5302
Sølvdip/ smykkerens Exocyd, for bruk på verksted/butikk. Meget effektiv på både sølv, gull, kobber etc, 1l.

Verktøysett



QUICK
SERVICE
SWISS MADE

7812

Innhold:
2 skrutrekkere 1,0-1,6 mm med reserveblad
Barettutstøter 6767 med reservespisser
Korntang
Plastkorntang
Flattang
Teleskopisk lupe 2,5 x
Kasseåpner Jaxa Mini
Kassekniv
Stiftutstøter 7230 med reservestift
Målebånd
Pusseklut mikrofiber



202160

Innhold:
2 skrutrekkere 1,0-1,6 mm
Barettutstøter
Dumont korntang
Teleskopisk lupe 10 x
Kasseåpner skrubaklokk
Kasseåpner pressbaklokk
Kassepute
Stiftutstøter
Spisstang
Delebok



202105

Innhold:
3 skrutrekkere 1,0-1,6 mm
Barettutstøter
Korntang
Plastikk-korntang
Kasseåpner skrubaklokk
Kasseåpner pressbaklokk
Sortiment med baretter
Lupe 4x



202101

Innhold:
2 skrutrekkere 1,0-1,6 mm
Barettutstøter
Plastkorntang
Kasseåpner skrubaklokk
Kasseåpner pressbaklokk

Pakninger



950048

60 pakninger
O-ring
Ø utv: 36,5-41,1
Tykkelse: 0,6-0,8



950047

70 pakninger
O-ring store
Ø utv: 41,4-62,6
Tykkelse: 0,5-1,3



950039

30 pakninger
Sansfil flate, røde
Ø utv: 18,6-33,0
Tykkelse: 0,9



950040

120 pakninger
O-ring
Ø utv: 17,1-37,3
Tykkelse: 0,6-1,0



950042

120 pakninger
Flate
Ø utv: 16,8-37,0
Tykkelse: 0,5



950041

120 pakninger
O-ring tynne
Ø utv: 15,8-39,5
Tykkelse: 0,4-0,6

Baretter



Kragebaretter, 10 pk:
 Ø 1,3: 06 - 24 mm
 Ø 1,5: 06 - 32 mm
 Ø 1,8: 08 - 40 mm
 Ø 2,0: 20-22 /22-24 /24-26 /26-28 /
 28-30/ 30-32



Faste baretter, 10 pk:
 Ø 1,0: 06 - 20 mm
 Ø 1,8: 09 - 25 mm



Låsbarretter 10 pk:
 Ø 1,17: 09 - 20mm
 Ø 1,30: 08 - 26 mm
 Ø 1,50: 16 - 20 mm



Låsbarretter 10 pk:
 Rundt hode, for sikkerhetslås
 Ø 1,6: 18 og 22 mm

Baretter i sett

Sett 99058

Kragebaretter
 1000 stk. Ø 1,3 mm, 6 - 20 mm
 50 av 6, 7, 8, 9, 10, 11, 13,
 15, 17, 19
 100 av 12, 14, 16, 18, 20

Sett 99060

Kragebaretter
 1000 stk. Ø 1,5 mm, 7 - 24 mm
 50 av 7, 8, 9, 10, 11, 12, 13, 14,
 15, 17, 19, 21, 22, 24
 100 av 16, 18, 20

Sett 99062

Kragebaretter
 1000 stk. Ø 1,8 mm, 8 - 24 mm
 50 av 8, 10, 12, 15, 17, 19, 23, 24
 100 av 14, 16, 18, 20, 21, 22

Sett 99064

Kragebaretter
 690 stk. 6 - 24 mm
 Ø 1,3: 6, 7, 8, 9, 10, 11, 12, 13, 14, 15, 16, 18
 Ø 1,5: 8, 10, 12, 13, 14, 18, 16, 17, 18, 19, 20, 21, 22, 24
 Ø 1,8: 8, 10, 12, 14, 15, 16, 17, 18, 19, 20, 21, 22, 23, 24

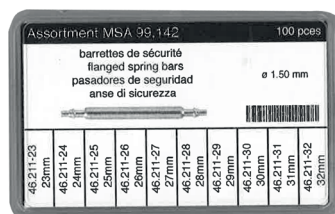

Sett 986995

Kragebaretter
 360 stk. Ø 1,3 mm, 8 - 24 mm
 20 av 8, 9, 10, 11, 13, 14,
 15, 16, 17, 19, 22, 24
 40 av 12, 18, 20

Sett 99142

Kragebaretter
 100 stk. Ø 1,5 mm, 23 - 32 mm
 10 av hver mm bredde

Sett 99096

FASTE baretter
 60 stk. Ø 1,8 mm, 10 - 24 mm
 6 av 10, 12, 14, 16, 17, 18, 19, 20, 22, 24

Sett 979995

Kragebaretter
 360 stk. Ø 1,5 mm, 8 - 24 mm
 20 av 8, 9, 10, 11, 13, 14,
 15, 16, 17, 19, 22, 24
 40 av 12, 18, 20

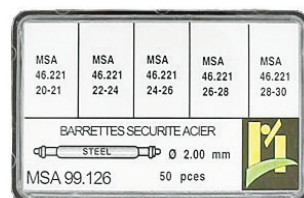

Sett 978995

Kragebaretter
 360 stk. Ø 1,8 mm, 8 - 24 mm
 20 av 8, 9, 10, 11, 13, 14,
 15, 16, 17, 19, 22, 24
 40 av 12, 18, 20

Sett 99126

Universalbaretter
 50 stk. Ø 2,0,
 20/22-28/30mm.

Sett 982999

FASTE baretter
 100 stk. 6 - 23 mm
 Ø 1,4 mm: 6, 8, 10, 12, 13,
 Ø 1,8 mm: 14, 16, 17, 18, 19, 23

Låsbarerter i sett



Sett 987995

Låsbarerter

180 stk. Ø 1,3 mm, 8 - 20 mm

10 av 8, 9, 10, 11, 15, 16, 17, 19

20 av 12, 14, 18, 20

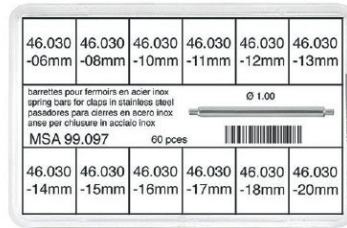

Sett 99097

Låsbarerter

60 stk. Ø 1,0 mm, 6 - 20 mm

5 av 6, 8, 10, 11, 12, 13, 14

15, 16, 17, 18, 20

Sett 99098

Låsbarerter

60 stk. Ø 1,3 mm, 10 - 20 mm

5 av 10, 11, 12, 13, 14, 15

16, 17, 18, 19, 20

Sett 99152

Låsbarerter

60 stk. Ø 1,5 mm, 10 - 20 mm

5 av 10, 11, 12, 13, 14, 15

16, 17, 18, 19, 20

Splittstifter

Splittstifter, 10 pk:

Ø 0,8 mm: Alle bredder 8 - 30 mm

Ø 0,9 mm: Alle bredder 8 - 30 mm

Ø 1,0 mm: Alle bredder 8 - 30 mm

Ø 1,2 mm: Alle bredder 21 - 30 mm



Splittstifter, 100 pk:

Ø 0,8 mm: 12, 18, 20 mm

Ø 0,9 mm: 17, 18, 20 mm

Splittstifter i sett



Sett 99145

Splittstifter

100 stk. Ø 0,8 mm, 21-30 mm



Sett 99146

Splittstifter

100 stk. Ø 0,9 mm, 21-30 mm



Sett 99147

Splittstifter

100 stk. Ø 1,0 mm, 21-30 mm



Sett 99148

Splittstifter

100 stk. Ø 1,2 mm, 21-30 mm

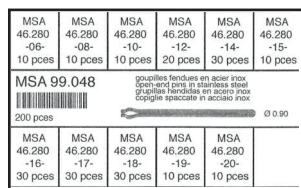

Sett 99048

Splittstifter

200 stk. Ø 0,9 mm

10 av 6, 8, 10, 15, 19, 20,

20 av 12,

30 av 14, 16, 17, 18

Sett 99049

Splittstifter

200 stk. Ø 1,0 mm

Samme fordeling

Sett 99137

Splittstifter

200 stk. Ø 0,8 mm

Samme fordeling



Sett 950251

Splittstifter

540 stk. Ø 0,8, 0,9 og 1,0 mm

Per tykkelse:

10 av 10, 11, 13, 15, 17, 20, 21, 22

20 av 12, 14, 16, 18, 19

Stift og hylse i sett



1359-99251

Hylse og stift

40+40stk.

Ø 1,0/0,7-

Ø 1,8/1,4mm

L.30 mm

SETT

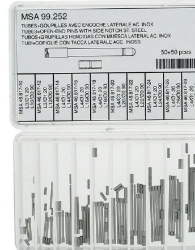

1359-99252

Hylse og stift

50+50stk.

Ø 1,2/ 0,9

L.10-28 mm

SETT



1359-99253

Hylse og stift

50+50stk.

Ø 1,2/ 0,9

L.11-29 mm

SETT

Riflet lenkestift

Riflet lenkestift, 10 pk:

Ø 0,9 mm: 6, 8, 10, 12, 14, 16, 17, 18, 19, 20, 21, 22

Ø 1,0 mm: 6, 8, 10, 12, 14, 16, 17, 18, 19, 20, 21, 22



Riflete stifter i sett

16mm	Ø8mm	Ø10mm	Ø12mm	Ø14mm	Ø16mm
0 pcs	10 pcs	10 pcs	10 pcs	10 pcs	30 pcs
upilles molëtées en acier inox urled pins in stainless steel apillas moleteadas en acero inox piglie zingmate in acciaio inox					
Ø 0,90 MSA 99.133					
3.283	46.283	46.283	46.283	46.283	46.283
7mm	-18mm	-19mm	-20mm	-21mm	-22mm
0 pcs	40 pcs	10 pcs	40 pcs	10 pcs	10 pcs

Sett 99133

Riflete stifter
200 stk. Ø 0,9 mm, 6-22 mm

Sett 99134

Riflete stifter
200 stk. Ø 1,0 mm, 6-22 mm

Sett 99210

Riflete stifter
200 stk. Ø 0,9 mm, 22-30 mm

Sett 99211

Riflete stifter
200 stk. Ø 1,0 mm, 22-30 mm

Sett 99212

Riflete stifter
200 stk. Ø 1,1 mm, 22-30 mm

Rørbarett for lenkelås

Rørbarett 10 pk:

Ø 1,1 mm: 12, 14, 16, 17, 18, 19, 20, 21, 22, 24

Ø 1,2 mm: 12, 14, 16, 17, 18, 19,34, 35

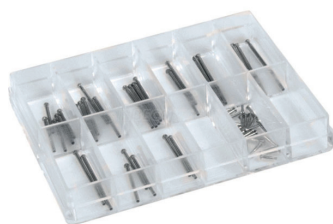

Sett 950499

Baretrør m/stifter for lås
30 stk. Ø 1,0mm
Lengde 10-20mm.



Sett 99.110

Rørbarett for lås
60 stk. Ø 1,2 mm
10, 12, 14, 16, 18, 20 mm.



Sett 950500

Stålstifter m/grad for lenke
60 stk.
L. 27 mm
Tykkelser: Ø 0,8-0,9-1,0-1,1-1,2mm
12 stk. av hver størrelse.

Diverse stifter

Stålstifter, 10 pk:

Lengde 30 mm

Ø 0,8 - 0,9 - 1,01,7 - 1,8 mm



Sett 950310

Koniske stålstifter
500 stk. assortert

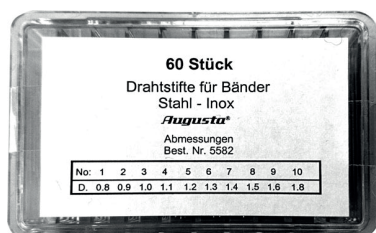

Sett 5582

Stålstifter
60 stk. lengde 30 mm
Ø 0,8 - 0,9 - 1,0 - 1,1
- 1,2, 1,3 - 1,4 - 1,5 -
1,6 - 1,8 mm

Sett 610995

Smygstoler 8-18mm /
60stk.ass.
Sorte.

Sett 610996

Smygstole 20-24mm /
30stk.ass.
Sorte.



Batterier

Vi har et stort lager av batterier.

- Fullsortiment av sølvoksyd og lithium urbatterier
- Alle aktuelle zink-luft høreapparater
- Stort utvalg av stavbatterier, også oppladbare
- Stort utvalg av spesialbatterier for foto og annet



- Grunnlagt i USA i 1906
- Mest kjente batterimerke i verden
- Anerkjent høy kvalitet
- Enormt produktspekter
- Levering på dagen

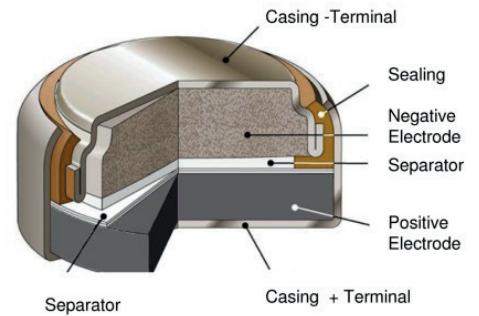

- «The Swiss Power Source»
- Verdens tredje største produsent av urbatterier
- Produsert batterier siden 1974
- Eid av Swatch Group siden 1982
- ISO-sertifisert siden 1999
- Kvikksølvfrie batterier siden 2010
- Fullt sortiment av sølvoksyd-, lithium-, og høreapparater
- Max Johanson og Kleiser AS er eneimportør til Norge

Bli batterikunde og få en gunstig avtale!

Klokkelenker og klokkeremmer

Vi har et stort utvalg klokkelenker og -remmer, vi lagerfører 200 ulike lenker og 400 ulike remmer. Du kan se hele sortimentet i nettbutikken. Velg produktgruppe "Lenker" eller "Remmer".



Cross Reference Guide
Interchangeabilités
Austauschbarkeit



RENATA No.	ENERGIZER EVEREADY	MAXELL PANASONIC SONY TOSHIBA	VARTA	RAYOVAC	DURACELL	TIMEX	CITIZEN	SEIKO	I.E.C. 60086-3 (60086-2)
301	301	SR43SW	V301	301	D 301/386	D	280-01	SB-A8	SR1142 (SR43)
303	303	SR44SW	V303	303	D 303/357	A	280-08	SB-A9	SR1154 (SR44)
309	309	SR754SW	V309	309	D 309/393				SR754 (SR48)
315	315	SR716SW	V315	315		HA	280-56	SB-AT	SR716 (SR67)
317	317	SR516SW	V317	317		CA	280-58	SB-AR	SR516 (SR62)
319	319	SR527SW	V319	319	D 319		280-60	SB-AE/DE	SR527 (SR64)
321	321	SR616SW	V321	321		DA	280-73	SB-AF/DF	SR616 (SR65)
329	329	SR731SW	V329	329					SR731
335	335	SR512SW	V335	335			280-68	SB-AB	SR512
337	337	SR416SW		337					SR416
339	339	SR614SW	V339						SR614
341	341	SR714SW	V341	341					SR714
344	344	SR1136SW	V344	344					SR1136 (SR42)
346	346	SR712SW	V346	346			280-66	SB-DH	SR712
350	350		V350						SR1136 (SR42)
357	357	SR44W	V357	357	D 303/357	J	280-62	SB-B9	SR1154 (SR44)
361	361	SR721W	V361	361	D 361/362	X	280-53	SB-BK/EK	SR721 (SR58)
362	362	SR721SW	V362	362	D 361/362	S	280-29	SB-AK/DK	SR721 (SR58)
364	364	SR621SW	V364	364	D 364	T	280-34	SB-AG/DG	SR621 (SR60)
365	365	SR1116W							SR1116
366	366	SR1116SW	V366	366			280-46		SR1116
370	370	SR920W	V370	370	D 370/371	Z	280-51	SB-BN	SR921 (SR69)
371	371	SR920SW	V371	371	D 370/371		280-31	SB-AN	SR921 (SR69)
373	373	SR916SW	V373	373		WA	280-45	SB-AJ/DJ	SR916 (SR68)
376	376	SR626W		376	D 376		MA		SR626 (SR66)
377	377	SR626SW	V377	377	D 377	BA	280-39	SB-AW	SR626 (SR66)
379	379	SR521SW	V379	379	D 379	JA	280-59	SB-AC/DC	SR521 (SR63)
380		SR936W							SR936
381	381	SR1120SW	V381	381	D 381/391		280-27	SB-AS/DS	SR1121 (SR55)
384	384	SR41SW	V384	384	D 384/392		280-18	SB-A1/D1	SR736 (SR41)
386	386	SR43W	V386	386	D 301/386	H	280-41	SB-B8	SR1142 (SR43)
389	389	SR1130W	V389	389	D 389/390	M	280-15	SB-BU	SR1130 (SR54)
390	390	SR1130SW	V390	390	D 389/390		280-24	SB-AU	SR1130 (SR54)
391	391	SR1120W	V391	391	D 381/391	L	280-30	SB-BS/ES	SR1121 (SR55)
392	392	SR41W	V392	392	D 384/392	K	280-13	SB-B1	SR736 (SR41)
393	393	SR754W	V393	393	D 309/393	F		SB-B3	SR754 (SR48)
394	394	SR936SW	V394	394	D 394		280-17	SB-A4	SR936
395	395	SR927SW	V395	395	D 395/399	LA	280-48	SB-AP/DP	SR927 (SR57)
396	396	SR726W	V396	396	D 396/397	V	280-52	SB-BL	SR726 (SR59)
397	397	SR726SW	V397	397	D 396/397	N	280-28	SB-AL	SR726 (SR59)
399	399	SR927W	V399	399	D 395/399	W	280-44	SB-BP/EP	SR927 (SR57)
LR44	A76	LR44	V136A	RW82	LR44	KA	280-904	SB-F9	LR1154 (LR44)
CR1025	CR1025	CR1025							CR1025
CR1216	CR/BR1216	CR/BR1216	CR1216	BR1216					CR1216
CR1220	CR1220	CR/BR1220	CR1220	CR1220	DL1220	PA		SB-T13	CR1220
CR1225	CR/BR1225	BR1225		BR1225					BR1225
CR1616	CR/BR1616	CR/BR1616	CR1616	BR1616	DL1616	YA	280-209		CR1616
CR1620	CR1620	CR1620	CR1620	CR1620	DL1620	EA	280-208		CR1620
CR1632		CR1632							
CR2016	CR/BR2016	CR/BR2016	CR2016	CR/BR2016	DL2016	FA	280-202/4/6	SB-T11	CR/BR2016
CR2025	CR2025	CR2025	CR2025	CR2025	DL2025	NA	280-205	SB-T14	CR2025
CR2032	CR/BR2032	CR/BR2032	CR2032	CR2032	DL2032			SB-T15	CR2032
CR2320	BR2320	CR/BR2320	CR2320	BR2320			280-201		CR/BR2320
CR2325	BR2325	BR2325		BR2325				SB-T12	BR2325
CR2430	CR2430		CR2430	CR2430	DL2430				CR2430
CR2450N	CR2450	CR2450	CR2450		DL2450				CR2450
CR2477N	CR2477	CR2477			DL2477				CR2477

RENATA No.	RAYOVAC	DURACELL ACTIVAIR	ENERGIZER	ENERGIZER AMPLIFIER	POWER ONE	PANASONIC	TOSHIBA	I.E.C.
ZA 10	10A	DA 10	AC230E/EZ	AC230	p10	PR230H	ZA10	PR70
ZA 312	312A	DA 312	AC312E/EZ	AC312	p312	PR312H	ZA312	PR41
ZA 13	13A	DA 13	AC13E/EZ	AC13	p13	PR13H	ZA13	PR48
ZA 675	675A	DA 675	AC675E/EZ	AC675	p675	PR675H	ZA675	PR44